

 PrimaLuna®

EvoLution Series

Tube Poweramplifiers

EVO 100-4

EVO 200-4

EVO 300-4

EVO 400-4

Version 2.1 – Feb 15, 2019

Version 2.2 – Feb 19, 2019





# PrimaLuna®

## EvoLution Series

### Table of Contents

Thank You!	3
Specifications	4ABCD
Warning - Package Contents - Initial Setup	5
Front and Back Panel Inputs, Outputs, Controls & Remote Function	6AB
Remote Control	7
Adaptive Auto Bias™ - Bias Switch	8
Ultralinear – Triode	9
Tube Basics	10
Fuse Protection - Electronic Protection	11
Troubleshooting	12
Notes	13, 14
Warranty Information	15
PrimaLuna Name & More	16

Copyright Durob Audio BV – 2019. All rights reserved.

Reproduction in whole or part of text, logo, graphics or schematics is strictly forbidden without permission, in writing, of Durob Audio BV.

The information in this manual is subject to change without further notice.



# PrimaLuna®

## EvoLution Series

### Thank You!

We would like to thank you for choosing one of our PrimaLuna EVO Tube Poweramplifiers at the heart of your music system. The EVO Tube Poweramplifiers are the newest versions of the original first members of our family of affordable, high-quality tube products. The designers and builders of the PrimaLuna equipment all have a long history in high-end audio. We feel we have shown with PrimaLuna that we are able to offer a range of affordable yet elegant audio instruments that can easily compete with today's most expensive brands and we assure you we will continue that way. We firmly believe that our quality level will set the bar at a difficult height for other products to match.

This PrimaLuna EVO Tube Poweramplifiers feature:

- Hand-made construction of a heavy-gauge, fully-vented steel chassis with a five coat finish, each coat hand-rubbed and polished, holding the finest point-to-point wiring, using workmanship that is normally only available at the highest price.
- Elegant style, heavy-metal remote controls for models that feature UL/TR choice.
- Premium parts that include toroidal and EI transformers for power supply; custom designed -in conjunction with one of the most prestigious transformer designers in the USA- encapsulated output transformers for lowest hum; wide bandwidth for great bass and extended highs; ceramic tube sockets; Nichicon and DuRoch capacitors; superfast Philips-rectifier-circuitry; gold-plated heavy-duty WBT style speaker terminals (all speaker connectors are solid shaft for better conductance, better sound, and higher reliability); gold-plated panel mounted RCA and XLR input and output jacks.
- The newest generation Adaptive Auto Bias™ exclusive to PrimaLuna. This circuit monitors and smoothly adjusts bias constantly and instantly, reducing maintenance and increasing performance due to the dramatic reduction in distortion. It comes with a new extensive output stage protection circuitry with +B relay to protect output transformers, resistors and high voltage power supply in case a tube fails.
- The EVO Tube Poweramplifiers come with a High/Low bias switch. This means that with the flip of a switch you can choose for the optimum bias setting for EL34 type of tubes or KT88 type of tubes. No hassle with screwdrivers, no messing around with meters etc. Just switch tubes, switch bias!
- All PrimaLuna power transformers include the PTP™ (Power Transformer Protection) circuit. When the power transformer overheats due to environmental circumstances, overloading or some problem in the unit, an internal thermal switch breaks the primary, allowing the unit to cool down before harm is done. After it's cooled, contact is restored and if nothing is broken, the amp will repower and function properly.
- All EVO Poweramplifiers come with a mono/stereo switch giving it a stereo and mono function.
- LIVE side of the AC input connector indicated by aluminium color screw.

We hope that our PrimaLuna EVO Tube Poweramplifiers will make you want to follow our next steps in expanding our range of products. If you have any questions or comments, don't hesitate to contact us. You can also share your thoughts with others, for example at the [FaceBook PrimaLuna Amplifiers Owners Group](#) or other review sites.

We keep our prices low by relying on word-of-mouth and customer feedback, and we would appreciate hearing what you have to say about our product. Finally, if you need service during or after the warranty period, please don't hesitate to contact us.

Thanks again for your support!

Herman van den Dungen  
DUROB AUDIO BV



# EvoLution Series

## Specifications

## Model EVO 100-4 for EL34 / KT88

Power UL	40 / 42 Watts per channel Stereo 82 / 84 Watts Mono
Frequency Response	12 Hz – 85 kHz +/- 1 dB 10 Hz – 95 kHz +/- 3 dB
THD with AABB	< 0.2% @ 1W; less than 2% at rated power Stereo < 0.17% @ 1W; less than 2% at rated power Mono
S/N Ratio	92 dB Stereo / 93 dB Mono
Input Impedance	100 kOhm
Input Sensitivity	880 / 880 mV (for rated power at maximum volume setting)
Maximum Gain	25 dB / 28 dB (EL34 / KT88)
Power Consumption	270 Watts / 280 Watts
Weight	Net weight: 37.4 lbs / 17 kg Shipping Weight: 46.2 lbs / 21 kg
Dimensions	15.9" x 11" x 7.5" / 405 mm x 280 mm x 190 mm (L x W x H)
Shipping Dimensions	18.4" x 15.2" x 12.2" / 468 mm x 385 mm x 315 mm (L x W x H)
Inputs	1 pair Stereo RCA , 1 piece Mono RCA
Outputs	4, 8 & 16 / 2, 4 & 8 Ohm Speaker Taps
Tube Complement	4 x EL34, 2 x 12AX7, 2 x 12AU7
Damping Coefficient	4 KD (1 kHz)

All PrimaLuna products come with PrimaLuna Silver Label tubes which are pre-selected by us following our simple 60 out of 100 rule (PTS™ - Premium Tube Selection) and as such, are already "special" when compared to other standard tubes on the market.



# EvoLution Series

## Specifications

## Model EVO 200-4 for EL34 / KT88

Power UL	44 / 45 Watts per channel Stereo 88 / 90 Watts Mono
Frequency Response	10 Hz – 65 kHz +/- 1 dB 10 Hz – 95 kHz +/- 3 dB
THD with AABB	< 0.1% @ 1W; less than 2% at rated power Stereo < 0.17% @ 1W; less than 2% at rated power Mono
S/N Ratio	92 dB Stereo / 93 dB Mono
Input Impedance	100 kOhm
Input Sensitivity	870 / 880 mV (for rated power at maximum volume setting)
Maximum Gain	26.5 dB / 29 dB (EL34 / KT88)
Power Consumption	280 Watts
Weight	Net weight: 50.6 lbs / 23 kg Shipping Weight: 61.6 lbs / 28 kg
Dimensions	15.9" x 14.4" x 8.1" / 405 mm x 365 mm x 205 mm (L x W x H)
Shipping Dimensions	22.7" x 18.4" x 12.4" / 577 mm x 468 mm x 315 mm (L x W x H)
Inputs	1 pair Stereo RCA, 1 piece Mono RCA
Outputs	4, 8 & 16 Ohm / 2, 4 & 8 Ohm Speaker Taps
Damping Coefficient	4 KD (1 kHz)

All PrimaLuna products come with PrimaLuna Silver Label tubes which are pre-selected by us following our simple 60 out of 100 rule (PTS™ - Premium Tube Selection) and as such, are already "special" when compared to other standard tubes on the market.



# EvoLution Series

## Specifications

## Model EVO 300-4 for EL34 / KT88

Power UL	44 / 43 Watts Stereo per channel; 85 / 84 Watts Mono
Power TR	22 / 25 Watts Stereo per channel; 45 / 50 Watts Mono
Frequency Response	10 Hz – 70 kHz +/- 1 dB 8 Hz – 75 kHz +/- 3 dB
THD with AAB	< 0.1% @ 1W; less than 2% at rated power / < 0.17% @ 1W
S/N Ratio	91 dB (105 dB A Weighted)
Input Impedance	100 kOhm
Input Sensitivity	870 / 880 mV for rated power at max volume setting
Maximum Gain	26 dB / 29 dB
Power Consumption	300 Watts
Weight	Net weight: 66 lbs / 30 kg Shipping Weight: 77 lbs / 35 kg
Dimensions	15.9" x 15.2" x 8.1" / 405 mm x 385 mm x 205 mm (L x W x H)
Shipping Dimensions	22.7" x 18.4" x 12.4" / 577 mm x 468 mm x 315 mm (L x W x H)
Inputs	1 pair Stereo RCA & XLR, 1 piece Mono RCA & XLR
Outputs	4, 8 & 16 Ohm / 2, 4 & 8 Speaker Taps
Tube Complement	4 x EL34, 6 x 12AU7
Damping Coefficient	4 KD (1 kHz)

All PrimaLuna products come with PrimaLuna Silver Label tubes which are pre-selected by us following our simple 60 out of 100 rule (PTS™ - Premium Tube Selection) and as such, are already “special” when compared to other standard tubes on the market.



## EvoLution Series

### Specifications

### Model EVO 400-4 for EL34 / KT88 / KT120 / KT150

Power UL	70 / 72 / 85 / 89 Watts Stereo per channel; 140 / 145 / 175 / 188 Watts Mono
Power TR	38 / 43 / 45 / 51 Watts Stereo per channel; 82 / 88 / 94 / 109 Watts Mono
Frequency Response	9 Hz – 60 kHz +/- 1 dB 8 Hz – 70 kHz +/- 3 dB
THD with ABB	< 0.1% @ 1W; less than 2% at rated power
S/N Ratio	95 dB – 105 dB A Weighted
Input Impedance	100 kOhm
Input Sensitivity	1100 mV for rated power at max volume setting
Maximum Gain UL	27 dB / 26.5 dB / 26.5 dB / 26 dB; 30 dB / 30 dB / 30 dB / 30 dB
Maximum Gain TR	25.5 dB / 24 dB / 24 dB / 24 dB; 28 dB / 27 dB / 27 dB / 27 dB
Power Consumption	470 Watts / 480 Watts / 540 Watts / 550 Watts
Weight	Net weight: 68.2 lbs / 31 kg Shipping Weight: 79.2 lbs / 36 kg
Dimensions	15.9" x 15.2" x 8.1" / 405 mm x 385 mm x 205 mm (L x W x H)
Shipping Dimensions	22.7" x 18.4" x 12.4" / 577 mm x 468 mm x 315 mm (L x W x H)
Inputs	1 pair Stereo RCA & XLR, 1 piece Mono RCA & XLR
Outputs	4, 8 & 16 Ohm / 2, 4 & 8 Ohm Speaker Taps
Tube Complement	8 x EL34, 6 x 12AU7
Damping Coefficient	7 KD (1 kHz)

All PrimaLuna products come with PrimaLuna Silver Label tubes which are pre-selected by us following our simple 60 out of 100 rule (PTS™ - Premium Tube Selection) and as such, are already "special" when compared to other standard tubes on the market.



# EvoLution Series

## Warning

To prevent serious injury, electrical shock or fire:

- Do not operate with the bottom plate removed. Keep away from rain and moisture.
- Disconnect the ac mains cable before changing fuses and/or tubes.
- Do not replace fuses with any fuse other than the same type and rating as used by the factory.
- Do not replace tubes without reading instructions.
- Do not replace fuses or tubes if you have any doubt about your ability to do so.
- We accept no responsibility for any personal or material damage due to incompetent use or users.

## Package Contents

EVO Tube Poweramplifier	1 piece
EVO Remote Control	1 piece
Power Cord	1 piece
This Owner's Manual	1 piece
White Gloves	1 pair
Tube Complement	See specification pages
Spare Mains Littelfuse Model 213 fuse	1 piece
Spare Adaptive Auto Bias Littelfuse Model 213 fuse	1 piece

## Initial Setup

- Don't wear a watch or rings and carefully remove the EVO Tube Poweramplifier from its packaging. Once the plastic bag has been removed, use the white gloves to prevent fingerprint smudges.
- Remove the tube cage by carefully pulling it up and away from the amplifier.
- Remove the protective foam surrounding the tubes.
- Tubes are already installed.
- Check that each tube is firmly and straightly seated in its socket. Use gloves provided.
- Replace cage back in its place if desired.
- Check to see the power switch is off (down) and the bias-selector switch is in the correct position.
- Connect output of preamp with input of power amp.
- Connect your speaker wires, positive to positive, negative to negative. This unit is non-inverting.
- Plug the power cord into the amplifier, then into the wall socket.
- Switch on the sources and after that the preamplifier and wait for 1 minute to stabilize the circuit.
- Switch the power amplifier on.
- The tubes will be warmed up and ready to use in about 60 seconds.





# EvoLution Series

## Front Panel Outputs, Controls & Remote Function

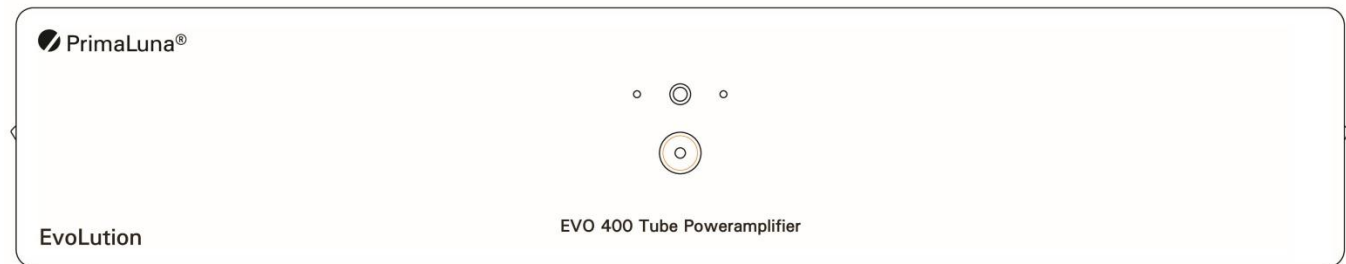
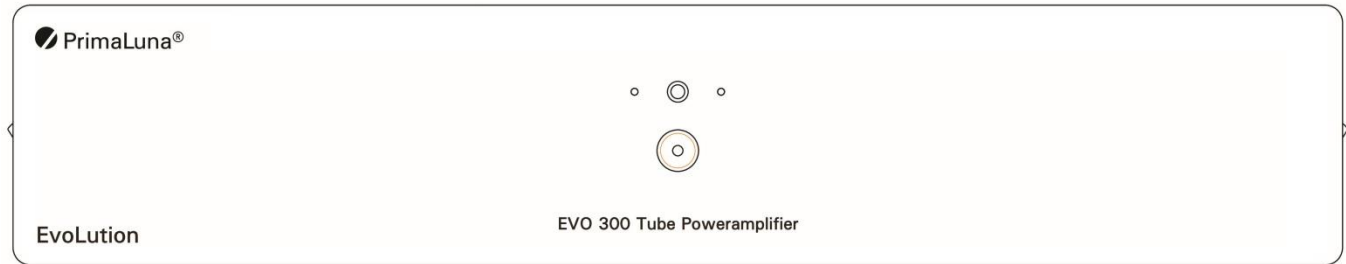
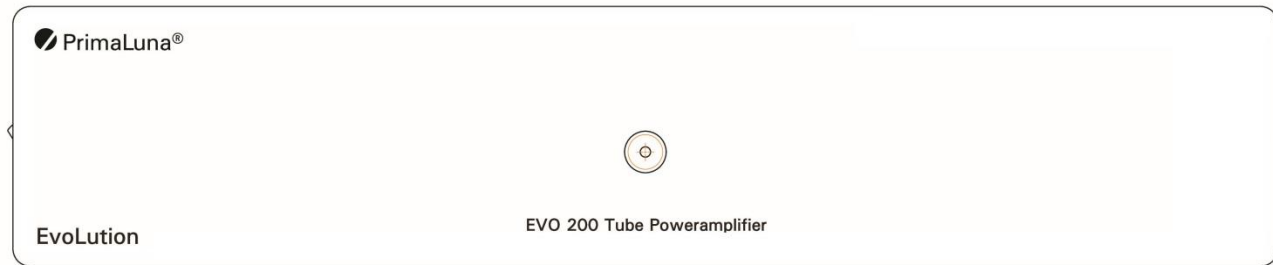
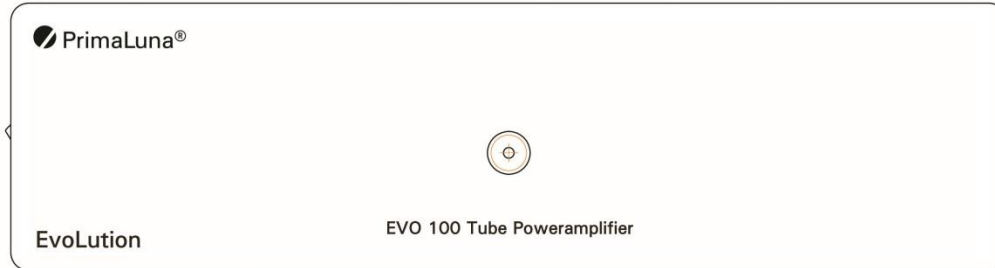

PrimaLuna front panels are made from machined aluminium, finished to match the black/blue metallic chassis. No controls are available from the front. The power switch and auto bias fuse are located on the left side of the amp, just behind the front plate, the bias switch on the right side, just behind the front plate.

## EvoLution Series

### Back Panel Inputs, Outputs

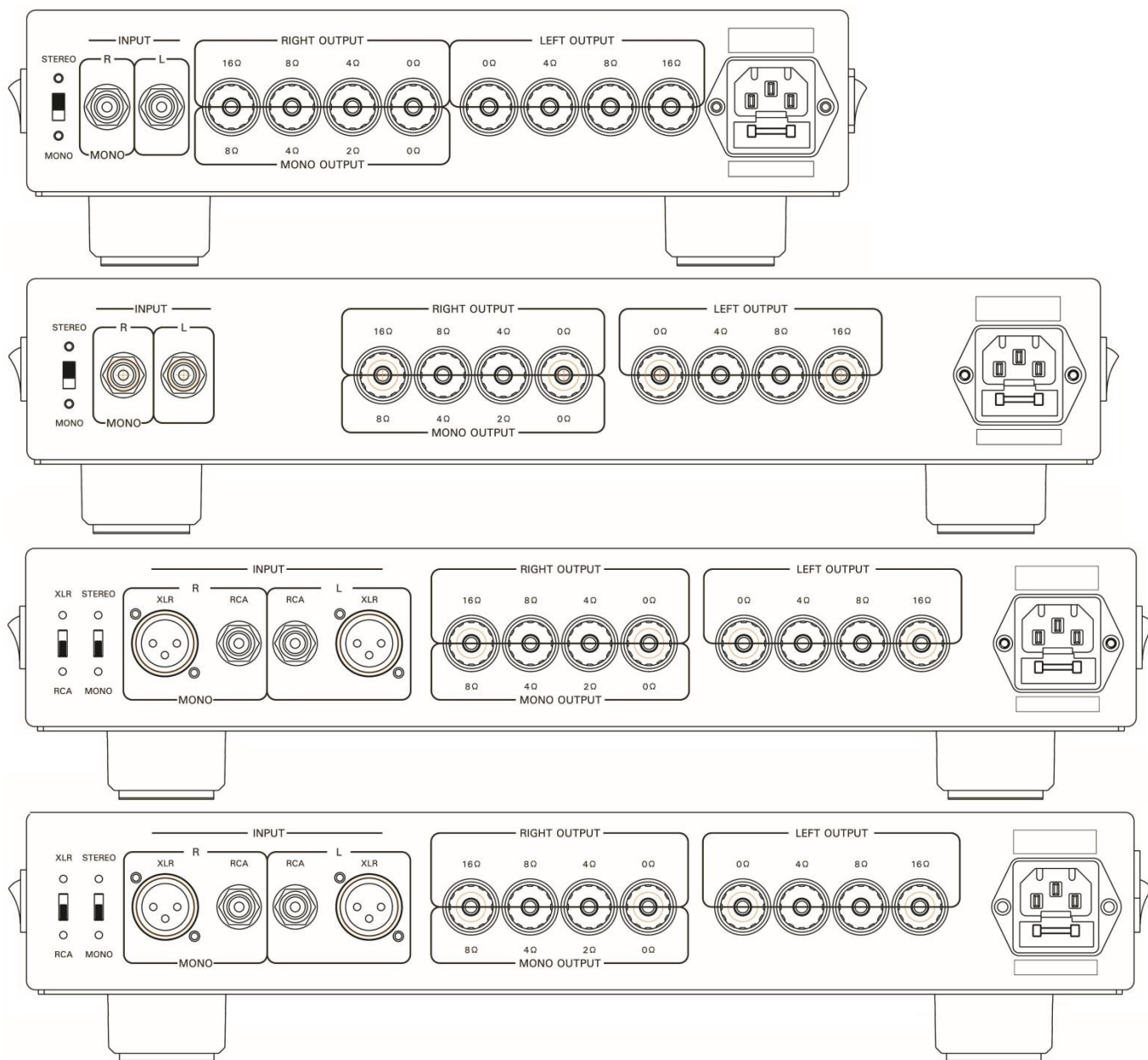

At the rear panel, you will find your inputs and speaker terminals. Input can be switched -NOT while the amplifier is on!- as mono or stereo input. The speaker taps also can be used as mono or stereo output(s). Attach the (+) from your loudspeaker to the 2, 4, 8 or 16 Ohm terminal that most closely matches the average impedance of your loudspeakers. The (-) from your loudspeaker attaches to the 0 Ohm terminal. Experiment using the 2, 4, 8 or 16 Ohm (+) terminal to find what's the best match with your speakers. Don't make any assumptions. Trust your ears.

## EvoLution Series

### Remote Control

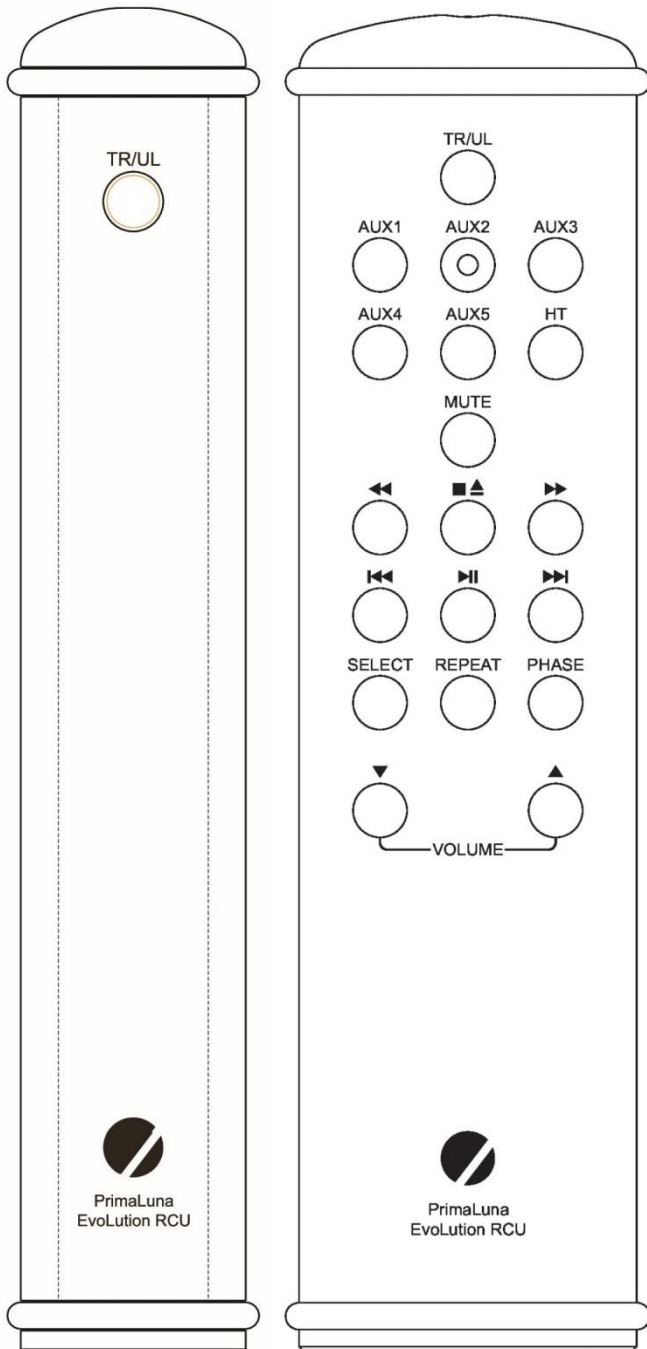

Attention! Due to increasingly stringent safety measures, it can happen that the remote control arrives without batteries installed.

The function of the EVO Tube Poweramplifier Remote Control is self-explanatory. It controls the TR/UL selection. This is also possible with the larger system remote, which also has source selection, volume & mute functions. The system remote will also control the basic functions of the PrimaLuna CD players.

The EVO Remote Controls have two high-quality rubber rings on each end to protect it from becoming damaged or damaging your furniture. These rings can be easily removed in case batteries have to be replaced.

In the event your remote control does not function, please first check the battery/batteries. To access the battery compartment, remove the rubber rings and unscrew the back plate.

Do NOT use rechargeable batteries!

You can also check your remote here:

<https://primalunablog.com/?s=remote>

If the remote still does not function, contact your dealer for further assistance.

# PrimaLuna<sup>®</sup>

## EvoLution Series

### Adaptive Auto Bias<sup>™</sup>

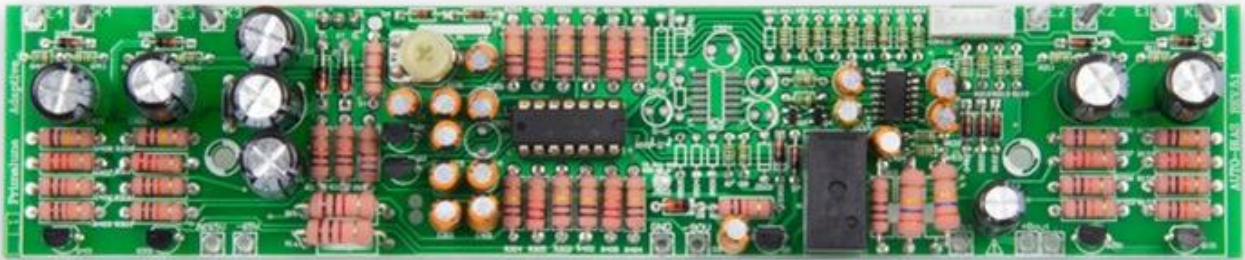

Our PrimaLuna exclusive Adaptive Auto Bias<sup>™</sup> circuit monitors and smoothly adjusts bias constantly and instantly, reducing maintenance and increasing performance due to the dramatic reduction in distortion. The genius of this design is that the Adaptive Auto Bias<sup>™</sup> actually improves the overall sound quality and performance of the amp. Between 12 and 30 Watts, measured distortion levels drop by over 40%. In addition, tubes do not have to be matched, and there are no bias (re-)adjustments needed, ever. The new generation Adaptive Auto Bias<sup>™</sup> circuit comes with a new extensive output stage protection circuitry with +B relay to protect output transformers, resistors and high voltage power supply in case a tube fails. This circuit is also protected with an easily accessible fuse located next to the on / off power switch.

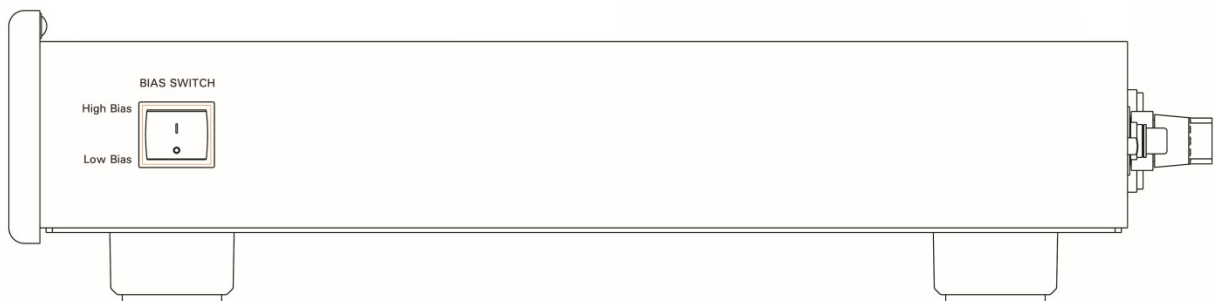

### Bias Switch

The EVO Tube Poweramplifiers come with a bias level switch. This means that by the flip of a switch you can choose the optimum bias setting. Low Bias for EL34s (or equivalent tubes) or High Bias for KT88s, KT120s or KT150s (or equivalent tubes). No hassle with screwdrivers, no messing around with meters etc. If you swap tubes, simply flip the switch -with volume down!- for optimum bias!

Should you use the “wrong” bias setting for the tubes in use, don’t worry. It just means you did not choose the “optimum” bias setting as decided by the PrimaLuna design team.



## EvoLution Series

### **Ultralinear – Triode Switching**

Your EVO 300 and 400 poweramplifier affords you the opportunity of switching between Ultralinear and Triode modes by remote control. You need not turn off the amp to do so; you can switch while the unit is operating. Although a faint click might be heard through your speakers, it is in no way harmful. Your EVO 300 and 400 poweramplifier always starts in Ultralinear mode when powered up. Centered on the front panel you find two color LEDs which indicate the mode in which the amp is functioning: Red—Ultralinear; Green—Triode.

### **Ultralinear Mode - Triode Mode**

The term ultralinear design exerts a tighter grip on the speakers and produces music more likely to be described as accurate, dynamic, with great inner detail. The top and bottom end take on more “pop” and excitement. Triode sound is best described as warmer on top and bottom, a little compressed, with the midband now slightly more pronounced. The sound is more relaxed. In absolute terms it will not play as loud as maximum power drops by roughly half compared to Ultralinear.

# PrimaLuna®

## EvoLution Series

### Tube Basics

The 12AX7 and 12AU7 tubes will have a life of about 5,000 to 10,000 hours. However, the life span of power tubes is more difficult to predict. It greatly depends on how "gently" or "roughly" you use your amplifier. In general, under normal conditions, you can figure between 2,000 and 3,000 hours.

Here are some guidelines on using tubes:

- Do not use treatments on tube pins or in sockets.
- If you decide to experiment with other tube types, it's best not to swap tubes in and out repeatedly. To do so requires you to turn your amplifier off and on and you never want to cycle amplifiers on and off rapidly. They should be left off for at least five minutes. Further, every time you insert a tube, you stand a chance of loosening the tube sockets. It's okay to have fun, and we support that, but don't go crazy and swap tubes in and out twenty times a day.
- Do not leave the amplifier on 24 hours a day. Just a short warm-up is required for the PrimaLuna to get into its groove.
- Break-in yields improvements. Every tube, when new, needs to be left alone for a little while. So, when your amplifier is new, or when you re-tube it, allow a little time to settle in. There is, however, no fixed "time rule" for break-in.
- Tubes can vary electrically, and by plugging in the wrong type of tube you can damage the amplifier and void your warranty.
- Please note to use same type or equivalent tubes for a replacement!

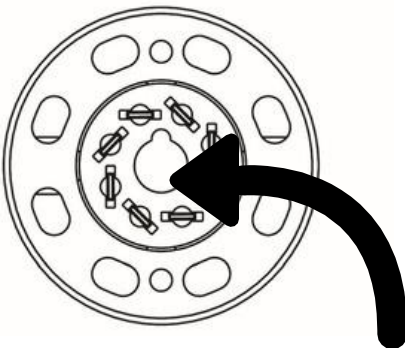

Some tubes and tube sockets have a "center key" which must line up! If you misalign them and use brute force, you will damage important and expensive parts of your amplifier!!

# PrimaLuna®

## EvoLution Series

### Fuse Protection

**Warning!** Fuses are safety valves. They should always be replaced with the exact same value and type. Never attempt to check or replace a fuse while the amp is plugged in. Turn it off and unplug the AC cord before continuing. Wait 10 minutes to let tubes cool down and the circuit to fully discharge.

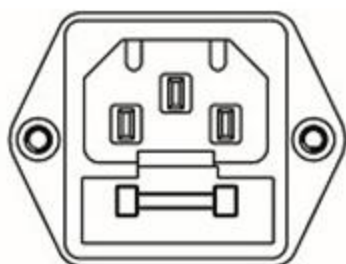

**Mains Fuse:** The mains fuse is located on the rear of the amplifier, just below the power cord socket (see picture on the left). The fuse rating is 1 x Littelfuse 213 Series 3.15A Slow Blow 5 x 20mm fuse for 100-125VAC and Littelfuse 213 Series 1.6A Slow Blow 5 x 20mm fuse for 200-250VAC. Always replace with the same type and value fuse! The fuse holder can be opened using a small slotted flat blade screwdriver.

The IEC connector is mounted with 2 different color screws. One silver, one black. The silver screw indicates the Live AC in the IEC connector. It helps with the "correct" connection to AC. Nevertheless always check the AC cable by measuring as not every AC cable is constructed the same way.

The Adaptive Auto Bias Board is protected with an easily accessible Littelfuse 213 315mA fuse located next to the on / off power switch.

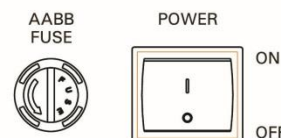

### Electronic Protection

The PrimaLuna EVO Tube Poweramplifiers are equipped with Soft Start™ and come with an extensive output stage protection circuitry with +B relay to protect output transformers, resistors and high voltage power supply in case a tube fails.

The board also comes with a BTI™ circuit. BTI™ stands for Bad Tube Indication (by the change of front LED to red), making tube-life again a bit easier. The BTI™ circuit is totally inactive during normal operation. However when one (or more) output tube(s) draw(s) significantly more current than normal for a couple of seconds, such as when a loudspeaker terminal short-circuits with volume turned up, or in the case of an output tube failure, the BTI™ circuit "reads" the changes as a potential threat and as a protective measure, interrupts the power supply. It indicates, by the led in front of the power tube, which tube might be bad. To reset, simply turn the power off and after two minutes, turn back on. **However**, you do not want to repower the unit until the cause of the failure has been identified and resolved. Switching the power back on too early also can fool the BTI circuit into acting as though the problem has not been totally resolved and it may put the amp back into protection mode again. So be sure to give it enough time to reset!



# PrimaLuna®

## EvoLution Series

### Troubleshooting Tips

No output. The power switch is on, but the power LED is off and tubes do not light up.

- *AC cable makes a bad connection in the IEC connector. Please check.*
- *Mains fuse is broken. Please check.*
- *PTP™ (Power Transformer Protection) protection may have switched off the power transformer. If so, the amplifier will switch on again after the internal temperature of the power transformer returns to normal. Overheating might be caused by higher environment temperature than normal or heavy use.*

No output. The power switch is on, the front LED is green and tubes do light up.

- *Adaptive Auto Bias Board fuse is broken. Please check.*

No output. The power switch is on, the front LED is red and LED in front of a power tube MIGHT light up.

- *BTI™ circuit has switched off the high voltage supply to the power output tubes. This can happen for example, when one (or more) output tube(s) draw(s) significantly more current than normal, like what can happen when a loudspeaker terminal is short-circuited with the volume turned up.*
- *In case of an internal output tube failure, the BTI™ circuit understands that there is a new situation which can cause harm to the amplifier or the loudspeaker, and the high voltage power supply to the output tubes is interrupted as a protective measure. The front LED will turn red and you might see a red LED in front of one or more power tubes. To reset, switch the amplifier's power off for at least two minutes, then switch back on. Of course, this should only be done after the cause of the failure has been identified and resolved. Switching the power back on too early can fool the BTI™ circuit into acting as though the problem has not been totally resolved and it may put the amp back into protection mode again. So be sure to give it enough time to reset.*

Noise or hum coming from one channel (eventually when you change your volume setting).

- *Noisy tube. At first swap the two inner small tubes left to right. If noise follows the tube swap then you have found the problem tube. If noise does not follow, swap the next set of two small tubes left to right, eventually the next set in case your amplifier has 6 small tubes.*
- *Possible bad output tube. Swap the output tubes in pairs from right to left. If hum follows the swap, swap the far left and far right tubes. If the hum returns to the original problem channel, you have found the problem tube. If not, swap the inside output tubes left to right.*

Noise/distortion coming from both channels.

- *Tubes may be in need of replacement.*





# EvoLution Series

**Notes**



# PrimaLuna®

## EvoLution Series

### Warranty Information

Two-year limited warranty

Six-month warranty on stock vacuum tubes

### Terms & Conditions

**1. Limited to the original purchaser.** This warranty is for the sole benefit of the original purchaser of the covered product, and may not be transferred to a subsequent owner.

**2. Conditions & Limitations.** This warranty is subject to conditions and limitations, as follows. This warranty is void and inapplicable if the product has not been used in accordance with the instructions found elsewhere in this manual, or if it has been misused, abused, damaged by accident or neglect, or in transport once in possession of purchaser. The warranty is also void if the product has been tampered with or has been repaired or modified by anyone other than Durob Audio BV or its specifically authorized representatives.

**3. Remedy.** If this product contains material, manufacturing, or workmanship defects, it must be packed in original packaging and returned to Durob Audio BV or its authorized representative via insured freight, at the owner's expense. Returned products must be accompanied by a written description of the defect, and a return authorization number (available from Durob Audio BV or the authorized representative via e-mail). Upon receipt of the defective product, Durob Audio BV or the authorized representative agrees to repair the product without charge for parts (except vacuum tubes if the unit is more than 6 months old), or labor. The product will then be returned via prepaid, insured freight, with the carrier at the sole determination of Durob Audio BV or the authorized representative. This constitutes the purchaser's sole remedy.

**4. Design change.** Durob Audio BV and its partners reserve the right to modify their products or change specifications at any time without obligation or liability to previous purchasers.

**5. Miscellaneous.** Any implied warranties relating to the above product shall be limited to the duration of this warranty. This warranty does not extend to any incidental or consequential costs or damages to purchaser or third-parties. Our liability will be no more than the amount you paid for the product that is the subject of a claim. This is the maximum amount for which we are responsible. This warranty gives you specific legal rights. You may also have other rights which vary from country to country and state to state.



# PrimaLuna®

## EvoLution Series

### PrimaLuna Illumination

Herman van den Dungen: **PrimaLuna** ► *in the Italian language is "First Moon". My grandfather was the first "Herman". My grandmother, an aristocratic lady in a small Dutch village, had a special name for her husband: "Maantje", which means Little Moon (which became also the name of our small dog), van den Dungen. The people in the village adopted that name, and having a strong accent, they soon called him "Maontje" van den Dungen. My father's first name was Cor, but in the village, it was of course "Cor from Maontje van den Dungen". I was of course "Herman from Cor from Maontje van den Dungen" ..... etc. That's why I thought of First Moon as a brand name and that's why the logo is how it is .....◀*

Loris Arrigucci: **PrimaLuna** ► *believe it or not ... I discovered a small town located 50Km north of Milano called Primaluna!!! Please get yourself a map from Italy. You'll find Primaluna town near the upper-right corner. It is located 50Km north of Milano near the Lake of Como. This should eliminate every doubt regarding "Italian" origin of Primaluna name. I've read the "history" section of the Primaluna village web site and found the following (literally translated):*

*One probable interpretation of the name of the village comes from Latin "Primum Lumen", which means "First Light" of Christianity since the very first evidence of Christianity in this region dates 495 Annus Domini. "First Light" translates into "Prima Luce" in Italian and this seems very interesting to me: PrimaLuce (FirstLight) is the first light that we, hi-fi lovers with small budgets, can see in this world of darkness populated by way too expensive esoteric gears .....◀*



Please contact us for registering your **PrimaLuna EVO** tube product. We will keep you updated on any upgrades or any other information related to your product. If you wish to comment on your **PrimaLuna EVO** tube product, please do. If you want to send us a review of your experience with the amplifier, you are more than welcome to. If you want to discuss with other **PrimaLuna** owners, join the completely independent [FaceBook PrimaLuna Amplifiers Owners Group](#). If you have any technical questions, please don't hesitate to contact us. We thank you upfront for your time and attention.

National distribution:

Worldwide distribution:

Durob Audio BV  
P.O. Box 109  
5250 AC Vlijmen  
The Netherlands

Email: [primaluna@primaluna.nl](mailto:primaluna@primaluna.nl)  
Website: [www.primaluna.nl](http://www.primaluna.nl)